

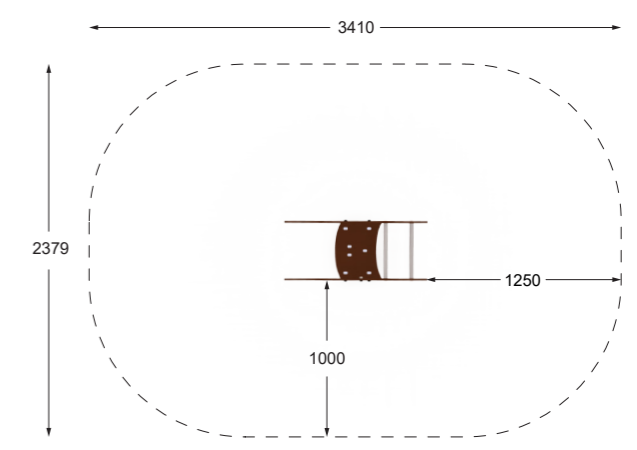

RE 221

Dolphin Springer | Product Sheet

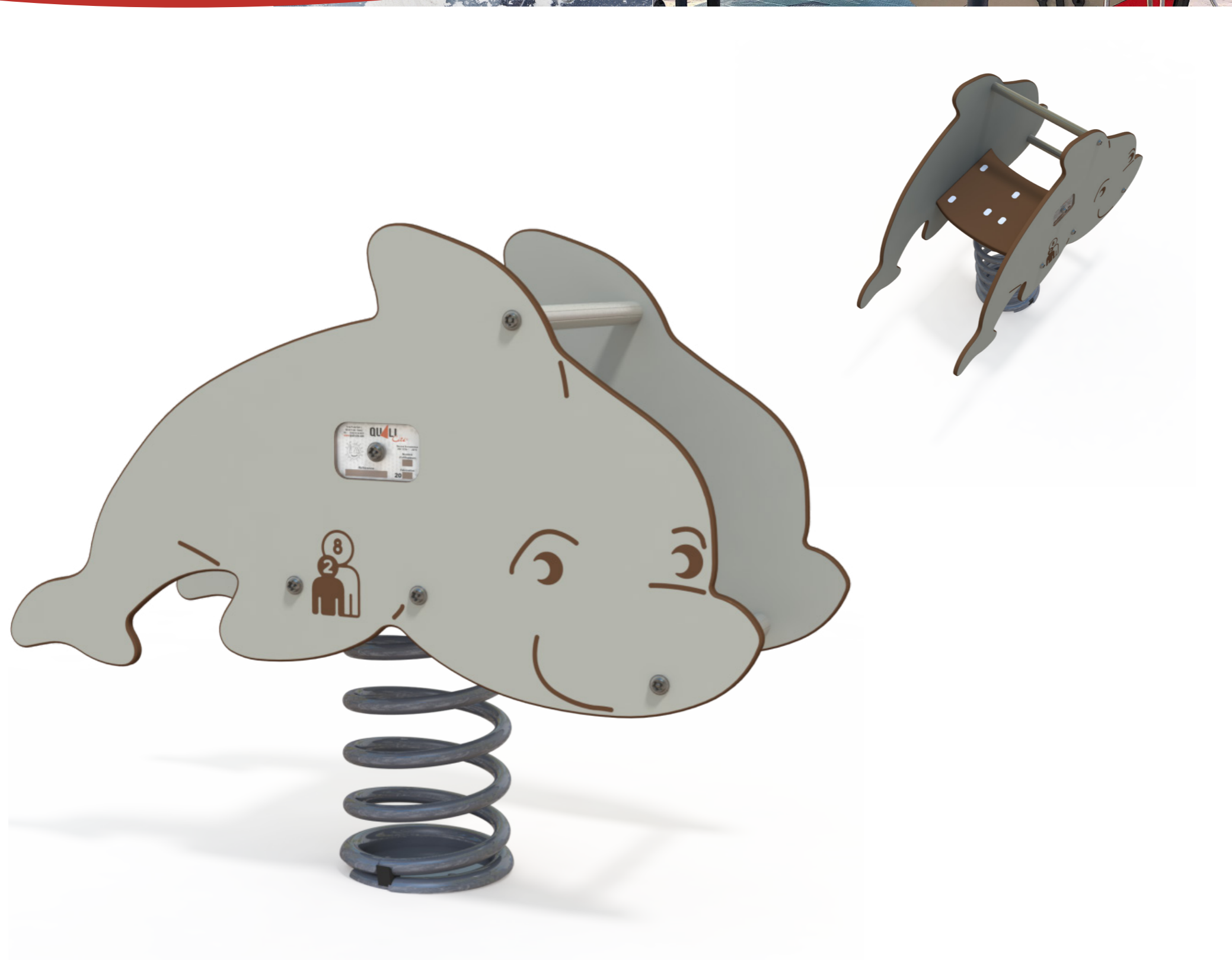

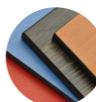

Range:	Springers
Ages:	2+ yrs
Capacity:	1
Equipment Size:	W 0.42m D 0.79m H 0.84m
Max FHO:	0.60m

Materials:

-  Compact Laminate Panels (HPL), made of duromer laminated at very high pressure with 2 coloured decorative sides with anti-graffiti and anti-UV treatment.
-  Springs are made of phosphate-protected micro beaded blasted steel with an epoxy finish and galvanised steel anchoring systems.
-  Bolts and screws made entirely from stainless steel, incorporated with a mechanical vandalism assembly system using Torx screws with anti-tamper pins.

Play Value:

-  Rocking
-  Balance
-  Role play

Colours:

