



Product Specification

Compliance

AS16630:2021

Softfall Requirement

Free Height of Fall - 0.99m

Materials

- UV Stable HDPE
- Powder Coated Marine Grade Aluminium
- Powder Coated Stainless Steel
- Stainless Steel Fasteners
- Plastic Grab Handles

Key Benefits

The chin-up is efficient for cultivating upper body vigour and muscular stamina. It primarily focuses on the latissimus dorsi (large muscles at the back) and biceps (forearms) while also involving muscles in your back, shoulders, and forearms.

Chin-ups enhance upper body strength, force, and stability, contributing positively to lifting, pulling, and ascending actions.

Features



Plastic Grab Handles

The Chin Up Station is meticulously designed with plastic grab handles to prioritise user safety and comfort during exercise. These well-crafted components provide a steady and secure grip, allowing smooth and consistent motion throughout the twisting movements.



Stainless Steel Bar

The Chin Up Station is meticulously designed with a powder coated stainless steel bar, emphasising user safety and stability during exercise. The powder coated finish gives the Chin Up Station a sleek appearance. It enhances its resistance to corrosion and wear, extending its lifespan and maintaining its performance for users seeking reliable and robust fitness equipment.

Top View

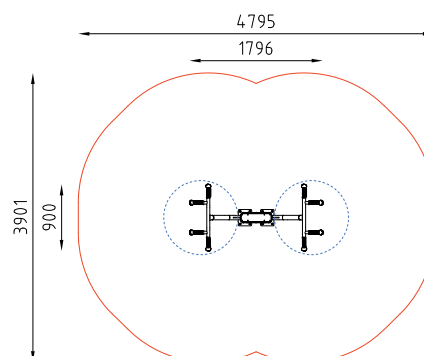

Training Space

Movement Space

Elevation

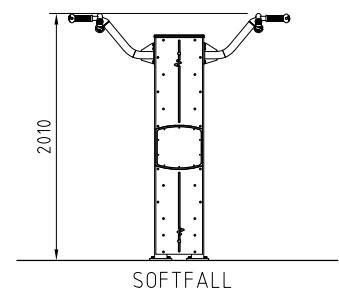

Materials Colour Options



WILLPLAY
PLAY • FITNESS • RECREATION



KEY:

HDPE UV Stable HDPE Plastic colour change options

PC Powdercoat colour change options

PLASTIC COLOURS: **HDPE**



MID GREY
158, 162, 162



WHITE/BLACK/WHITE

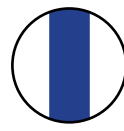

WHITE/BLUE/WHITE

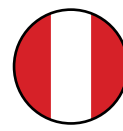

RED/WHITE/RED

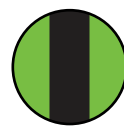

LIME/BLACK/LIME



YELLOW/BLACK/YELLOW

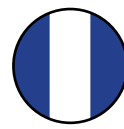

BLUE/WHITE/BLUE



GREEN/WHITE/GREEN

POWDERCOAT COLOURS: **PC**

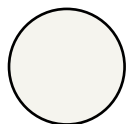

GLOSS WHITE
244, 244, 238



ANODIC SILVER
186, 191, 191



OLDE PEWTER
110, 113, 115



IRONSTONE
72, 76, 82



MONUMENT GREY
62, 59, 56



SATIN BLACK
44, 44, 44



CLASSIC CREAM
227, 209, 176



GOLD PEARL
168, 134, 64



YELLOW GOLD
244, 167, 28



ORANGE X15
227, 126, 41



FLAME RED
152, 43, 46



DARK VIOLET
82, 58, 110



BLAZE BLUE
0, 107, 177



LYKRA
200, 216, 83



CRYSTAL MINT PEARL
73, 165, 144



LEAF GREEN
74, 138, 64



MISTLETOE GREEN
23, 105, 55



HAWTHORN GREEN
48, 66, 56

