

# Transporter 1 PW

Wall panel Transporter pw is a panel especially for mounting a round wall game on the wall. The panel has the appearance of a spaceship with monster in it.

The unique design is made of FSC-certified birch wood that is lacquered with antibacterial lacquer. Thanks to the high quality and the use of sustainable materials, the Transporter pw guarantees years of playing pleasure. The panel can be combined with all round wall games.

Graphic colours Pantone no.

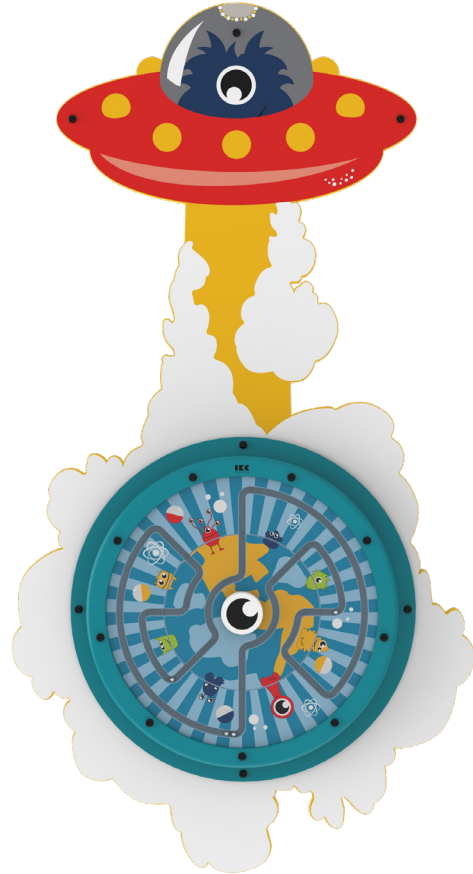

## Wall plate | Transporter 1 PW

Article no.	Size HxWxD	Mounting	KG	
PP00609	170,1x90,2x0,9 cm	wallmount	7 KG	MDF, Stainless steel



**TÜV SGS** All our products are inspected, tested and certified by SGS and TÜV.

**EN 71** European standard EN 71 specifies safety requirements for toys. Compliance with the standard is legally required for all toys sold in the European Union.

**FSC** All our products only use FSC certified wood, so eco- and environment friendly!

**CE** Our products are conform with health, safety and environmental protection standards for products sold within the EU.

**IKC | HQ EUROPE**  
 Dronten | The Netherlands  
 +31 (0)321 38 77 30  
 sales@ikcplay.com  
 www.ikcplay.com

**IKC | HQ ASIA**  
 Shanghai | China  
 +86 (0) 21 6506 1232  
 sales.cn@ikcplay.com  
 www.ikcplay.com.cn

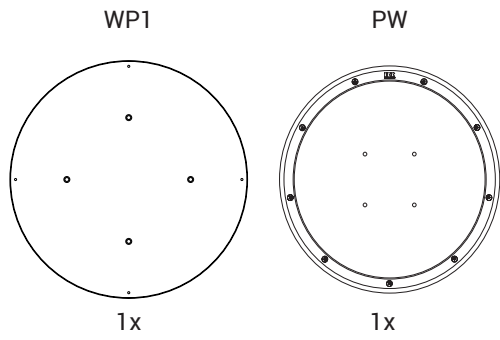

Required tools

Drill

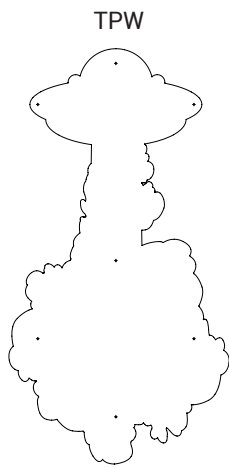
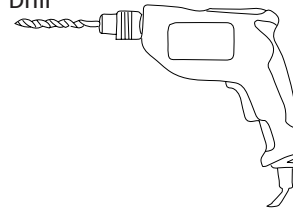

Screws

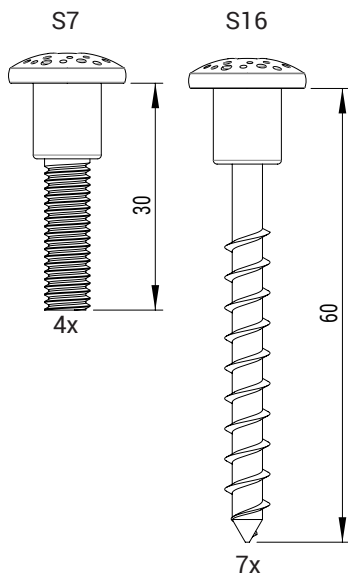

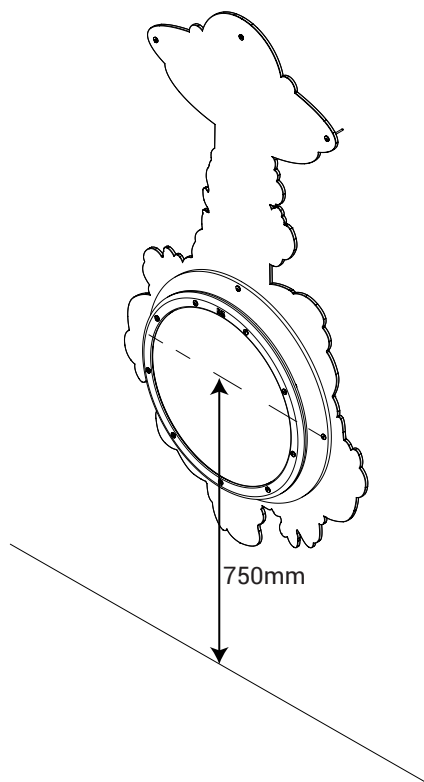

To ensure maximum play comfort the middle screwholes should be 750mm from the ground

