

# Transporter 2 PM

Wall panel Transporter pm is a panel especially for mounting a square wall game on the wall. The panel has the appearance of a spaceship with monster in it.

The unique design is made of FSC-certified birch wood that is lacquered with antibacterial lacquer. Due to the high quality and the use of durable materials, the Transporter pm guarantees years of playing pleasure. The panel can be combined with all square wall games.

Graphic colours Pantone no.

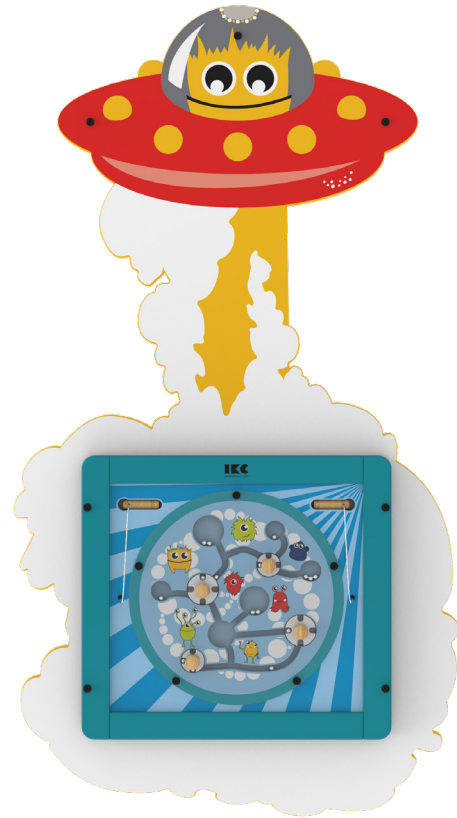
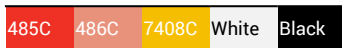

## Wall plate | Transporter 2 PM

Article no.	Size HxWxD	Mounting	KG	
PP00610	158,5x87x0,9 cm	wallmount	7 KG	MDF, Stainless steel



All our products are inspected, tested and certified by SGS and TÜV.

European standard EN 71 specifies safety requirements for toys. Compliance with the standard is legally required for all toys sold in the European Union.

All our products only use FSC certified wood, so eco- and environment friendly!

Our products are conform with health, safety and environmental protection standards for products sold within the EU.

**IKC | HQ EUROPE**  
 Dronten | The Netherlands  
 +31 (0)321 38 77 30  
 sales@ikcplay.com  
 www.ikcplay.com

**IKC | HQ ASIA**  
 Shanghai | China  
 +86 (0) 21 6506 1232  
 sales.cn@ikcplay.com  
 www.ikcplay.com.cn

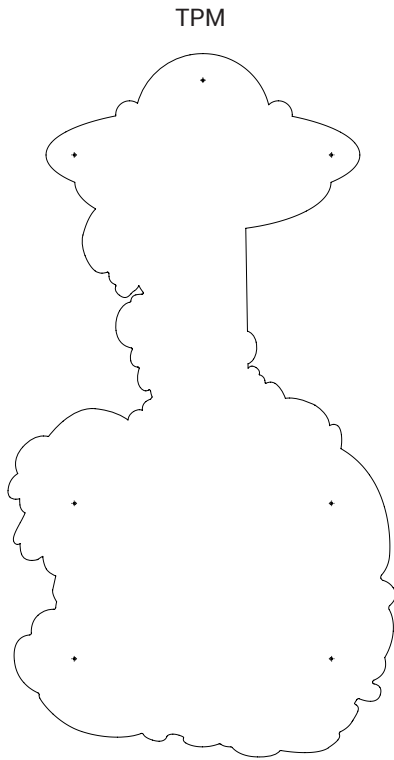

Required tools

Drill

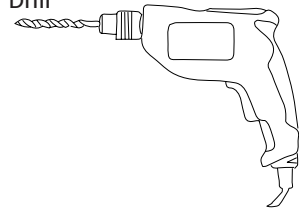

PM

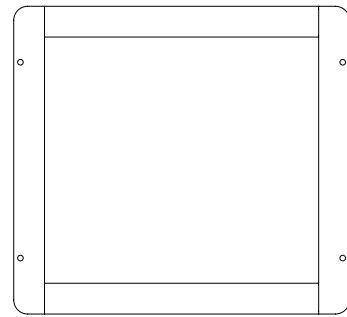

Screws

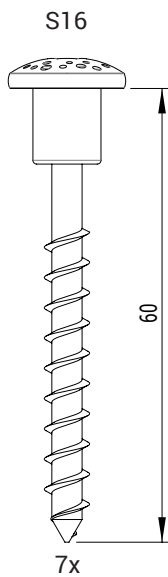

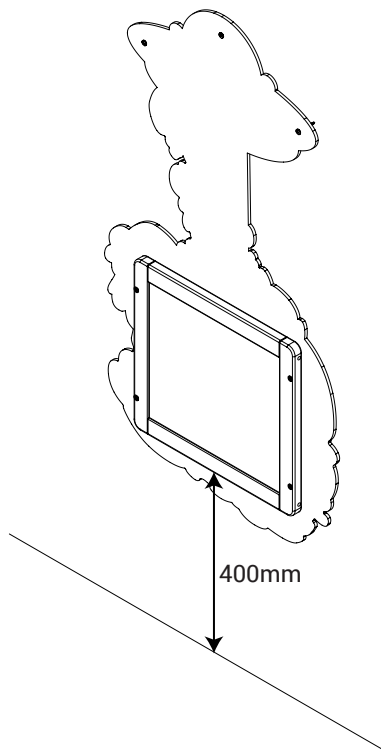

To ensure optimum play comfort the playmodule should be mounted at the following height.

S16



7x

TPM



PM

